

**Datasheet: Necsel™ Red High Power FC Bar**

These specifications are for the Necsel red high power fiber-coupled bar package. The centroid of the wavelength spectrum will be within the indicated wavelength range.



Model #	Symbol	Min. (nm)	Typical (nm)	Max. (nm)
Red-HP-FC-63x	$\lambda$	634	637	642

**Operating Wavelengths**

Laser Parameter	Symbol	Min.	Typical	Max.	Unit
Operating Power (CW)	$P_{op}$	-	5.0	-	W
Module Operating Temperature [non-condensing atmosphere]	$T_{Thermistor}$	-	25	30	°C
Center Wavelength [at 25°C and $P_{op}$ ]	$\lambda$	634	637	642	nm
Spectral Width @ FWHM	$\Delta\lambda$	-	1	3	nm
Wavelength Temperature Coefficient	-	-	0.2	-	nm/°C
Threshold Current	$I_{th}$	-	4.0	-	A
Slope Efficiency	$\eta$	-	0.8	-	W/A

**Power Supply Requirements**

Operating Voltage	$V_{op}$	-	2.4	3.0	V
Operating Current	$I_{op}$	-	10	12	A

**Fiber Specifications**

Fiber Core Diameter (Centration $\leq 10 \mu\text{m}$ )		0.400		mm
Connector Type (Nose length 0.3850 - 0.3863 in., 9.779 – 9.812 mm)		SMA-905		
Numerical Aperture		0.22		

## Outline Drawing and Electrical Connections

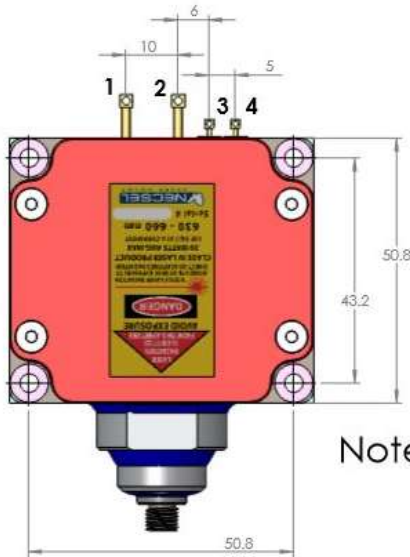

Electrical Connection Contact #	Description
1	Laser (+)
2	Laser (-)
3	Thermistor
4	Thermistor



Note: Package is electrically positive

nylon shoulder washer electrical insulator shown in all views

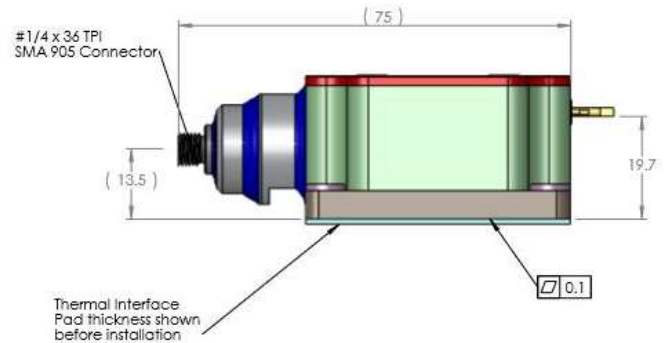
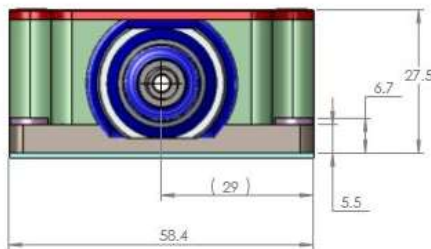

Necsel follows a policy of continuous product improvement and may change product descriptions and specifications at any time without notice. Necsel offers a limited product warranty to ensure customer satisfaction. Standard terms and conditions can be found on the web at <http://necsel.com/terms-conditions>. This product is solely intended to be integrated into a laser product certified by the Customer. The Customer acknowledges that their product(s) that incorporate Necsel laser products must comply with the applicable regulations before it can be sold.

