



OCAM²K

Data Sheet

July 2015

FAST LOW LIGHT LOW NOISE SCIENTIFIC CAMERA

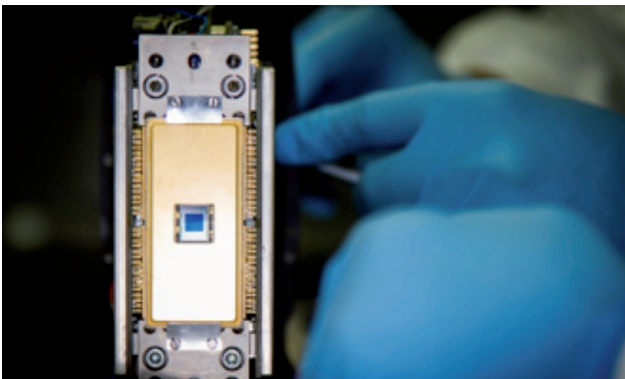

MAIN FEATURES

- Sub-electron readout noise*
- Up to 2067 FPS Full Frame
- 3700 fps in 2x2 binning mode
- 95% peak QE typical (Deep Depletion Silicon)
- Ultra-low latency CameraLink™ Full interface : 43 μ s

OTHER FEATURES

- 240x240 pixels state of the art EMCCD
- Wide 24 μ m pixels
- 14 bits precision A/D converter
- Cooled operation for low dark current
- Integrated cooling temperature controller
- Fully sealed resistant aluminum body with low thermal gradient
- Clock & trigger input / output for synchronous operation
- Custom design and Read Out modes available upon request



* With EMCCD Gain

THEORY OF OPERATION

OCAM²K is a high speed low noise camera able to run at 2067 fps with subelectron readout noise. To achieve this performance, **OCAM²K** uses the **E2V CCD 220 EMCCD**, an 8 output split frame transfer **CCD**. To minimize smearing, the **CCD220** high speed metal buttressed clock lines are driven by **OCAM²K** at a speed as high as 7 Mlines/s transferring each frame in the store section in only 12 microseconds.

OCAM²K also offers an extremely low latency : 43µs between exposure and first pixel availability.

OCAM²K WITH CCD220 TYPICAL PERFORMANCES

Test measurement	Result	Unit
Mean readout noise at 2000 fps and multiplication gain ~600	0.3	e ⁻
Quantization	14	bits
Dark signal at 2000 fps at -45°C	<0.01	e ⁻ pixel ⁻¹ frame ⁻¹
Detector Operating Temperature	-45	°C
Peak Quantum Efficiency at 650nm, STD Silicon	92	%
Peak Quantum Efficiency at 650nm	95	%
Linearity at gain x1000 from 10 e ⁻ to 150 e ⁻	<3	%
Linearity at gain x1 from 15,000 e ⁻ to 150,000 e ⁻	<3	%
Image Full Well capacity at gain x1	270 000	e ⁻
Parallel CTE at gain x1, 2000 fps	>0.99995	N/A
Serial CTE at gain x1, 2000 fps	>0.99994	N/A
Maximum deviation from peak to valley over the light sensitive area	0.7	µm
Optical distance from CCD Image Plane to front of Window	3.33	mm
Angle between CCD Image Plane and front of Window	<0.2	°

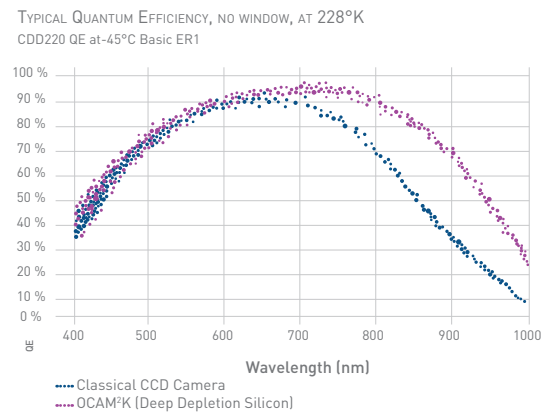
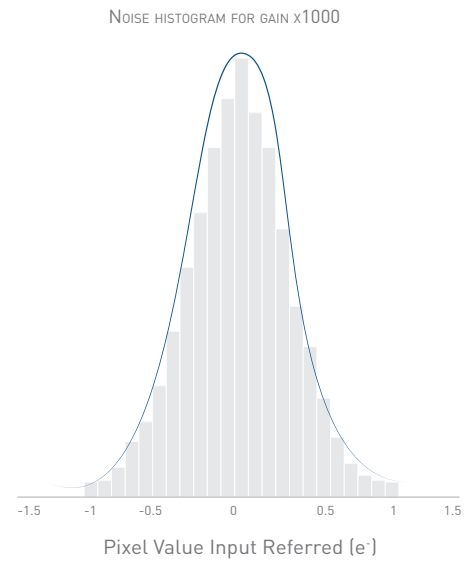

WAVEFRONT SENSOR OPTION

Microlens array specifications (standard proposal, customizable on request)	Result	Unit
Focal length (distance to maximum intensity) @ 633nm	22	mm
Number of sub-apertures	20 x 20	N/A
Lens shape	Square	N/A
Lens pitch	288	µm
Lens clear aperture	>286	µm
Lens array position on substrate	Centered	N/A
Fill factor	>98	%



OCAM²K

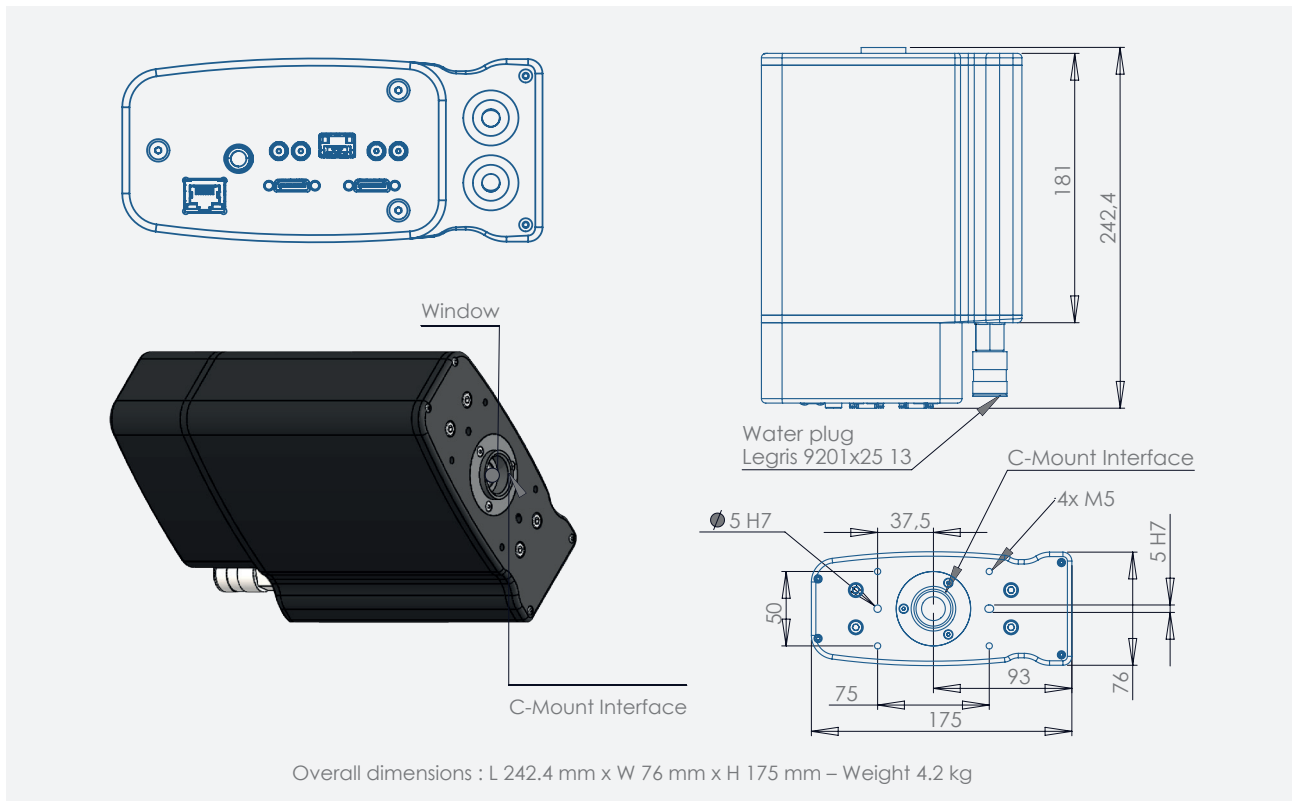

APPLICATIONS

OCAM²K is already used in various fields:

- Adaptive Optics for Astronomy
- Cellular Microscopy
- Space debris tracking
- Fluorescence Microscopy
- Speckle Interferometry
- Secure laser communications (long distance, space to ground)
- Long range surveillance and Tracking



OCAM²K at SUBARU Telescope

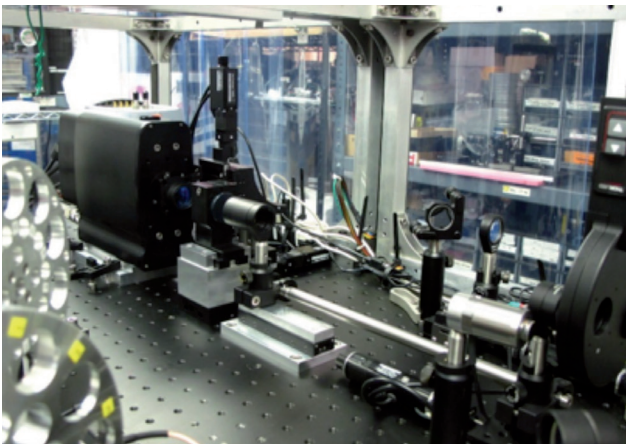

OCAM²K embedded in the
SUBARU Coronagraphic Extreme Adaptive Optics Project
Photo © SUBARU NAOJ

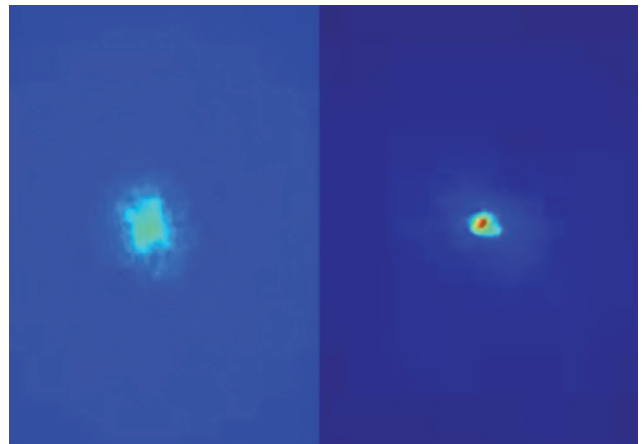

SUBARU images without and with AO with OCAM²K
Photo © SUBARU NAOJ

OUR CUSTOMERS AND PARTNERS

Today, world leading institutes and manufacturers on 4 continents have given us their trust, and we are proud to count among our partners and clients:

AIRBUS
GROUP

 **GIANT MAGELLAN TELESCOPE**

e2V



NASA-JPL

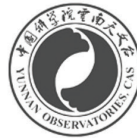

Hitachi High-Tech



OUR COMPANY

First Light Imaging designs and manufactures state of the art scientific cameras that combine extreme sensitivity and high speed for both visible and infrared spectra.

Coming from european academic research institutes, already multiple award-winning, First Light Imaging is recognized for the high performance of its products.

We develop our cameras around cutting-edge sensors. EMCCD or e-APD, we integrate the most challenging, difficult to harness detectors in complex optics systems.

Already at the heart of the Adaptive Optics systems for the world's biggest telescopes, our technology and detectors are also used in Medical Imagery, Defense, and Industry.

First Light Imaging SAS
100 route des Houillères
13590 Meyreuil
France
Tel.: + 33 4 42 61 29 20
www.first-light.fr
contact@first-light.fr

