

OPTIPHASE
A Halliburton Service

PZ1 High-speed Fiber Stretcher

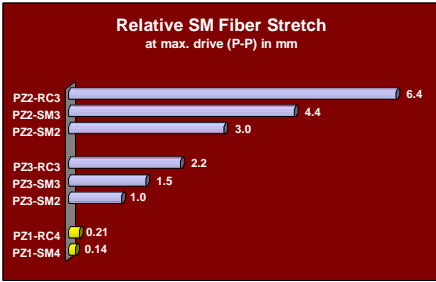

The **OPTIPHASE PZ1** is the high-speed member of our family of fiber stretchers. It is a fiber wound piezoelectric element for use in a wide range of optical interferometric measurement and sensing system applications. Typical uses include open loop demodulation, sensor simulation, variable optical delay, general purpose fiber interferometry and large angle modulation of interferometric phase.

Optiphase's expertise in the design, manufacture and use of all-fiber interferometers has produced a unique multi-layer winding approach resulting in an enhanced modulation function while maintaining a

high operational frequency [see charts]. PZ1 Fiber Stretchers are available with SM, commercial PM [PANDA or Bowtie] or RC [SM Reduced Cladding] fiber types.

The PZ1 delivers a high performance to cost ratio, exceeding all other known competitive devices. The compact and low-profile form factor makes the PZ1 easily configurable into small spaces. In addition, our fiber stretchers are unique in that they do not require proprietary drivers. For most low voltage applications (< ± 15V) our stretchers can be driven by standard electronics such as signal generators, op-amps or other laboratory equipment without modification. For more information on how to drive PZ1 stretchers see page 2.

FEATURES & BENEFITS

- High Speed
- Low Cost
- Compact package
- SM, PM or RC fiber
- Multiple termination choices
- Unique multi-layer winding
- Can be driven with general purpose electronics

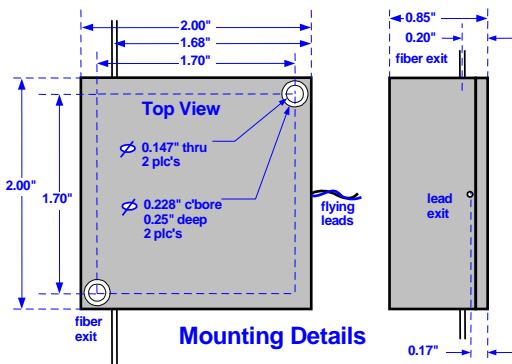

The PZ1's low profile and small footprint makes it easy to integrate into virtually any system device. Several termination options are available, making set-up and use quick and easy.

SPECIFICATIONS

PZ1 FIBER STRETCHER	SM FIBER 4-LAYER	PM FIBER 4-LAYER	PM FIBER 1-LAYER	RC FIBER 4-LAYER
Operational Wavelengths	780 - 1625 nm	780 to 1625 nm	780 to 1625 nm	780 to 1625 nm
Modulation Constant [< 5 KHz]	$1.3 / \lambda$ radians/V where λ wavelength in μm Example: $=1$ radian/V @ $1.3 \mu\text{m}$	$1.3 / \lambda$ radians/V where λ wavelength in μm Example: $=1.7$ radians/V @ $0.78 \mu\text{m}$	$0.325 / \lambda$ radians/V where λ wavelength in μm Example: $=0.2$ radians/V @ $1.5 \mu\text{m}$	$1.9 / \lambda$ radians/V where λ wavelength in μm Example: $=1.45$ radians/V @ $1.3 \mu\text{m}$
Fiber Stretch	0.14 μm / Volt	0.14 μm / Volt	0.035 μm / Volt	0.21 μm / Volt
Optical Path Displacement [n=1]	0.2 μm / Volt	0.2 μm / Volt	0.05 μm / Volt	0.3 μm / Volt
Time Delay	0.0007 ps / Volt	0.0007 ps / Volt	0.00017 ps / Volt	0.001 ps / Volt
Fiber Length	12.3 meters inclusive	12.3 meters inclusive	5 meters inclusive	17 meters inclusive
Fiber Wind	4-layer	4-layer	The 1-layer design preserves a high polarization extinction ratio reducing the modulation constant.	4-layer
Fiber Type [See chart pg. 2]	SM [various] 245 μm jacket	PM [various] 245 μm jacket		RC SMF [80/165] 165 μm jacket
Extinction Ratio	Not applicable	≤ -20 dB typ / Near IR ≤ -16 Bowtie	≤ 24 dB bare leads; ≤ 22 dB with connectors	Not applicable
Optical Loss		≤ 0.5 dB, typical 0.2 dB (excluding connectors)		
Maximum Voltage Range		$\pm 500\text{V}$ [off resonance, 1000V P-P]		
Frequency Range		See chart page 2, specified at 1550 nm		
Linearity error (typ)		Drive $< 30\text{V}$ p-p: $< 0.5\%$ Drive $< 100\text{V}$ p-p: $< 1\%$ Full scale: $< 3\%$		
Impedance [below resonance]		Capacitance 2 nF nominal, floating		
Electrical Interface		18 inches, flying leads, #30		
Fiber Leads		1 meter, 900 μm loose tube		
Drive Polarity		White wire positive for positive stretch		
Connector Options		Bare fiber, FC/PC or FC/APC		
Operational Temperature Range		0° to 70°C		
Dimensions Weight		2.0" W x 2.0" D x 0.85" H 5.7 ounces / 162 grams		

Made in U.S.A.

PZ1 Modulation Characteristic Over Frequency Optical Path Displacement per applied volt (n = 1)

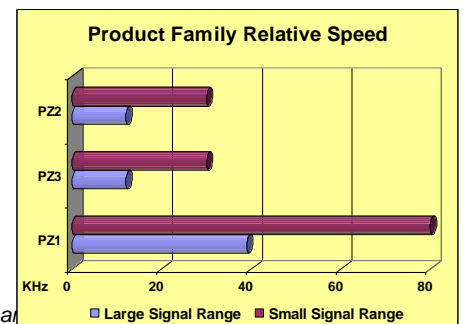
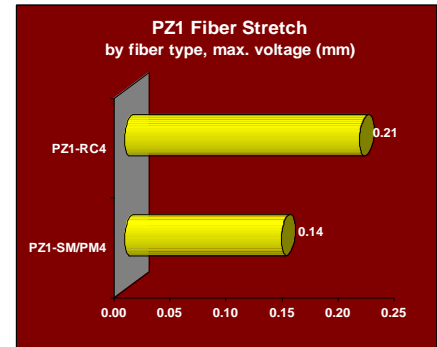
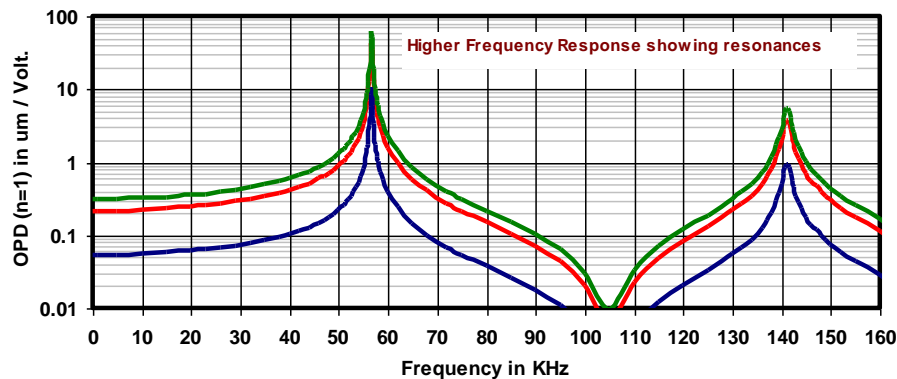
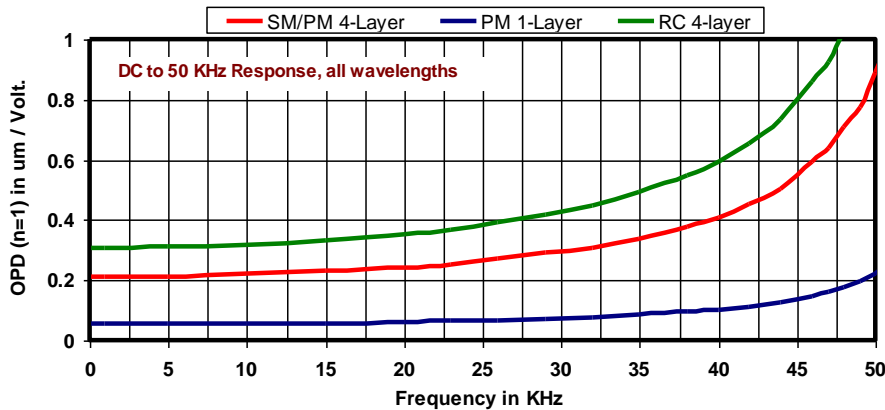

Small Signal = Frequencies extending past resonance, but at reduced modulation levels

PZ1 Fiber Stretcher Models

Model	Description
PZ1-SMF4-E	High-speed stretcher, 4-layer SMF28 fiber, bare leads, enclosed
PZ1-SMF4-PC-E	High-speed stretcher, 4-layer SMF28 fiber, FC/PC connectors, enclosed
PZ1-SMF4-APC-E	High-speed stretcher, 4-layer SMF28 fiber, FC/APC connectors, enclosed
PZ1-SM4-E-XXX	High-speed stretcher, 4-layer SM fiber, bare leads, enclosed
PZ1-SM4-PC-E-XXX	High-speed stretcher, 4-layer SM fiber, FC/PC connectors, enclosed
PZ1-SM4-APC-E-XXX	High-speed stretcher, 4-layer SM fiber, FC/APC connectors, enclosed
PZ1-PM4-E-XXX	High-speed stretcher, 4-layer PM fiber, bare leads, enclosed
PZ1-PM4-PC-E-XXX	High-speed stretcher, 4-layer PM fiber, FC/PC connectors, enclosed
PZ1-PM4-APC-E-XXX	High-speed stretcher, 4-layer PM fiber, FC/APC connectors, enclosed
PZ1-PM1-E-XXX	High-speed stretcher, 1-layer PM fiber, bare leads, enclosed
PZ1-PM1-PC-E-XXX	High-speed stretcher, 1-layer PM fiber, FC/PC connectors, enclosed
PZ1-PM1-APC-E-XXX	High-speed stretcher, 1-layer PM fiber, FC/APC connectors, enclosed
PZ1-RC4-E	High-speed stretcher, 4-layer RC fiber, bare leads, enclosed
PZ1-RC4-PC-E-XXX	High-speed stretcher, 4-layer RC fiber, FC/PC connectors, enclosed
PZ1-RC4-APC-E-XXX	High-speed stretcher, 4-layer RC fiber, FC/APC connectors, enclosed

Designed for Bipolar Drive

Optiphase fiber stretchers are designed to operate with a bipolar voltage drive. This is unique capability offers significantly greater convenience when compared to other approaches that mandate unipolar operation only with an offset voltage drive.

How to drive PZ1 stretchers

The equivalent circuit for the PZ1 fiber stretcher is shown below. At frequencies sufficiently below the first resonance (dc – 40 KHz) the effective impedance is capacitive, defined by $C0+C1+C2$, being approximately 2 nF. At 40 KHz, the magnitude of the impedance of this capacitance is 2000 ohms. Most laboratory equipment or circuitry can be used to drive this load with no modifications.

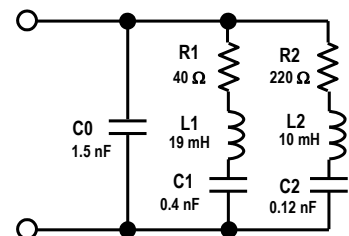

PZ1 Series Equivalent Impedance

DC - 10 KHz is approx $C0 + C1 + C2$ (= 2 nF)
First Resonance (57 KHz) defined by R1, C1, L1
Second Resonance (140 KHz) defined by R2, C2, L2

Trademarks are property of their respective manufacturers.

Part No. Designation and Fiber Types Used				
λ range (nm):	780-900	950-1200	1260-1400	1450-1625
XXX =	850	980	131	155
Y = P for Panda; B for Bowtie				
SM / SMF	Corning HI-780	Corning HI-980	Corning SMF28e+	
RC	NA	NA	Draka Elite 80 um BendBright-XS	
PM-Panda (4-layer)	Corning PM 850	Corning PM 980	NA	
PM-Panda (1-layer)	Same as above		Corning PM 1300	Corning PM 1550
PM-Bowtie	Fibercore HB800	Fibercore HB1000	Fibercore HB1250 ¹	Fibercore HB1500 ¹

¹ 4-layer Bowtie Extinction Ratio: -16dB