

## G15 Specification

TV SYSTEM	NTSC	PAL
IMAGE SENSOR	1/4-INCH CCD IMAGE SENSOR	
CCD TOTAL PIXELS	811(H) X 508(V)	795(H) X 596(V)
SCANNING SYSTEM	525 LINES, 60 FIELDS/SEC	625 LINES, 50 FIELDS/SEC
SYNC SYSTEM	INTERNAL	
MINIMUM ILLUMINATION	0.07 LUX F1.8 AGC ON B/W	
RESOLUTION	520 TVL	
ICR-SET CONTROL	AUTO / MANUAL	
WHITE BALANCE RANGE	3200 ~ 9600 °K	
WHITH BALANCE	ATW/AWB/FIX	
S / N RATIO	48DB ( MIN ) / 52DB ( TYP ) (AGC OFF , R=1 , APC OFF , Y-OUT)	
B.L.C. FUNCTION	SUPER BLC,48 ZONE BLC	
GAMMA CORRECTION	0.45 /1	
AGC	AUTO (18DB MAX)	
ALC	AUTO / FIX	
SENS UP	MAX. 32X SELECT BY OSD MENU	
IMAGE NEGATIVE	SELECT BY OSD MENU	
MONTION DETECT	48 ZONE (SELECT BY OSD)	
FREEZE FUNCTION	ALARM IN TRIGGER OR SELECT BY OSD	
CROSS LINE	ON/OFF SELECT BY OSD MENU (POSITION ADJ. BY SOFTWARE)	
ELECTRONIC SHUTTER	AES : 1/60(1/50) ~ 1/120,000 SEC. / MANUAL : 8 STEP	
LENS	10X OPTICAL ZOOM LENS ,F1.8~2.9 ,F=4.2MM~42MM	
	DIAGONAL	56.4 ° (W) / 6.1 ° (T)
	HOR.	46.4 ° (W) / 4.9 ° (T)
	VER.	35.6 ° (W) / 3.7 ° (T)
ZOOM	100X (10X OPTICAL 10XDIGITAL)	
FOCUS	AUTO / MANUAL	
POSITION	64 POSITION (ZOOM,FOCUS)	
VIDEO OUTPUT	COMPOSITE & Y/C OUTPUT 1.0VP-P AT 75 OHM	
CONTROL FUNCTION	OSD CONTROL ,, RS-232C/RS-485 (DRIVE OPTION)	
OSD LANGUAGE SELECT	ENGLISH / CHINESS_SIMP / JAPANESE	
OPERATION TEMPERATURE	-10°C TO 50°C	
OPERATIONAL HUMIDITY	WITHIN 85%RH	
POWER SUPPLY	DC12V±1V / 3.6W(MAX)	
DIMENSIONS	62MM X 36.8MM X43.8MM	

### Caution for Installation:

1. Avoid places where there is direct sunlight. When using the camera outside.
2. Be careful, never let any water in this equipment.
3. Do not directly touch the Sensor device. If necessary, use a soft cloth moistened with alcohol to wipe off the dust.
4. When the camera installs in dust or wet environment, please puts into the camera housing.
5. Be extra careful not to shake the camera.
6. Avoid places where temperatures exceed 50 °C or more.
7. Be extra careful not to mistake plug in connect.
8. The camera are only operated with regulative adaptor DC 12V, AC to DC non-regulative adaptor may cause camera damaged.

## G15 module

Dimension (Unit : mm /  $\pm 0.3\text{mm}$ )

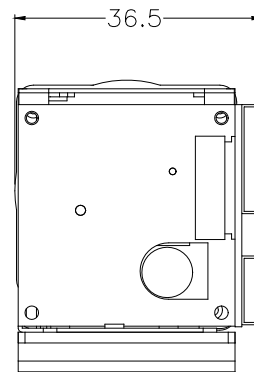
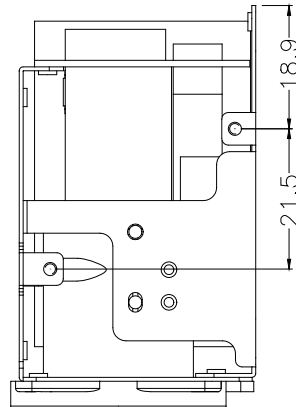
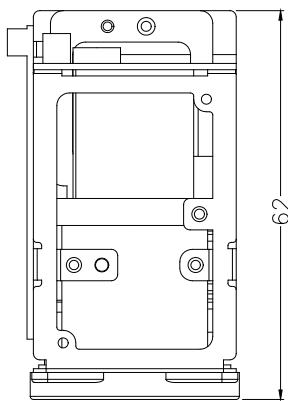
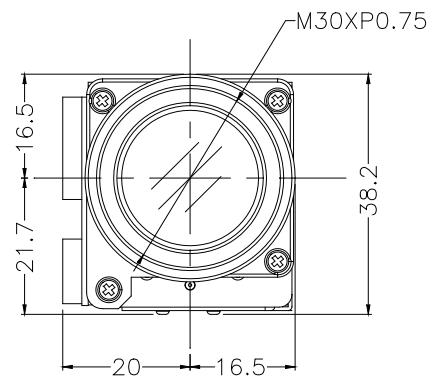

## CONNECTOR

### MAIN BOARD (CONNECTOR TO OPTION BOARD)

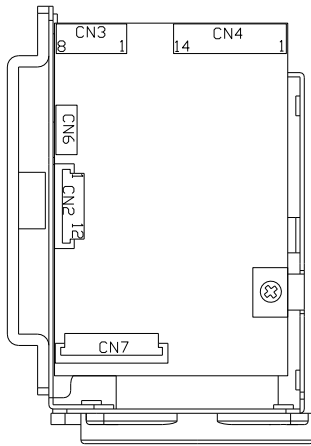

CN4		CN3		CN2		CN6	
P01	RXD	P01	GND	P01	DCK	P01	FOR MANUFACTURE NOT RELEASE
P02	TXD	P02	DOWN (OSD-SW)	P02	D0	P02	
P03	485CS	P03	UP (OSD-SW)	P03	D1	P03	
P04	MASK-OFF	P04	PRI (OSD-SW)	P04	D2	P04	
P05	+12V DC-in	P05	ENTER (OSD-SW)	P05	D3	P05	
P06	GND	P06	IRIS +/-	P06	D4	P06	
P07	Cout	P07	NEAR / INF	P07	D5		
P08	VBS	P08	TELE/WIDE	P08	D6		
P09	Yout			P09	D7		
P10	+3.3V			P10	HD		
P11	ALARM-in			P11	VD		
P12	Motion-out			P12	GND		
P13	V Rev.						
P14	H Rev.						

**Attention: CN4**

P01、P02: RS-232C With Driver

P03: Open Collector

P11、P12: Signal level H=3.3V±10%、L=0V±10%

P04、P13、P14: Inside Pull up (OPEN 3V)、Low active

**Attention: CN3**

P02~P05: Inside Pull up (OPEN 3V)、Low active

P06~P08: Inside Pull up 10KΩ & Pull down 10KΩ (OPEN 1.5V)

P06: OPEN OFF、0V~0.7V(-) / 2.3V~3V(+)

P07: OPEN OFF、0V~0.7V(INF) / 2.3V~3V (NEAR)

P08: OPEN OFF、0V~0.7V(WIDE) / 2.3V~3V (TELE)





**[03]. AGC, SENS SELECT MENU**

	A	G	C	S	E	N	S														
①	F	r	e	e	z	e	→	O	F	F											
								O	N												
②	A	G	C	A	U	T	O	-	-	-	-	■	-	-	-	-					
③	S	E	N	S	A	U	T	O	-	-	-	-	■	-	-	-	-				

This is used to select 「FREEZE」 and 「AGC」 & 「SENS」 function.

- ① 「FREEZE」 ON / OFF : ON (Freeze) / OFF(Unfreezef) .
- ② 「AGC」 : To adjust auto gain control, 0dB, 2.25dB, 4.5dB, 6.75dB, 9dB , 11.25dB , 13.5dB , 15.75dB , 18dB, 9 steps adjustable.
- ③ 「SENS」 : For low light application: 0 Frame , 6 Frame , 12 Frame , 16 Frame , 18 Frame , 22 Frame , 24 Frame , 30 Frame , 36 Frame, 9 steps adjustable.

After setting, push [PRI] key to go back to the main menu page.

**[04]. COLOR SELECT MENU**

	C	O	L	O	R																	
①	→	C	O	L	O	R	→	O	F	F												
								O	N													
								A	U	T	O											
②	W	B	→	A	T	W	R	-	-	-	-	■	-	-	-	-	B					
								A	W	B	R	-	-	-	-	■	-	-	-	-	B	
③	G	A	I	N	→	R	-	Y	-	-	-	-	■	-	-	-	-					
								B	-	Y	-	-	-	-	■	-	-	-	-			

This is used to control the color ON/OFF and white balance and the gain rate of RED & BLUE color.

- ① 「COLOR」 selector : OFF is monochrome image , ON is normal color image , AUTO is at low light AGC up, display image will be auto change to monochrome image.
  - ② 「WB」 White balance control : ATW is Auto trace white balance,can be adjust offset level. AWB is One push white balance. Push [ENTER] key 「AWB」 will start flicker, until flicker stop it will lock the current color temperature at the same time.
  - ③ 「GAIN」 : The gain rate of R-Y & B-Y can be adjusted separately.
- After setting, push [PRI] key to go back to the main menu page.











**[15]. MASK MENU**

	M:A S K								
①	→P O S I T I O N	N O =	6	:	4				
②	M:A S K	N O =	1						
③		→O F F							
④		O N	→H - S T A R T =	2	:	0			
⑤			H - E N D =	2	:	0			
⑥			V - S T A R T =	2	:	0			
⑦			V - E N D =	2	:	0			
⑧			C O N N E C T →O F F						
				O N					

This is used to select mask area size and position for each setable lens position.

- ①Lens position no. select(1~64)
- ②MASK NO. select(1~4)
- ③MASK area display ON / OFF select.
- ④Hor. direction start position.
- ⑤Hor. direction end position.
- ⑥Ver. direction start position.
- ⑦Ver. direction end position.
- ⑧ZOOM action to link mask area, ON / OFF select..

**[16]. OSD MENU**

	O S D								
①	→P O S I T I O N	→O F F							
		O N							
②	M O T I O N	→O F F							
		O N							
③	Z O O M M A G	→O F F							
		O N							

This is used to select on screen display ON / OFF select.

- ①POSITION NO. display ON / OFF select.
- ②MONTION action display ON / OFF select.
- ③ZOOM times display ON / OFF select.

**[17]. ZOOM+AF MENU**

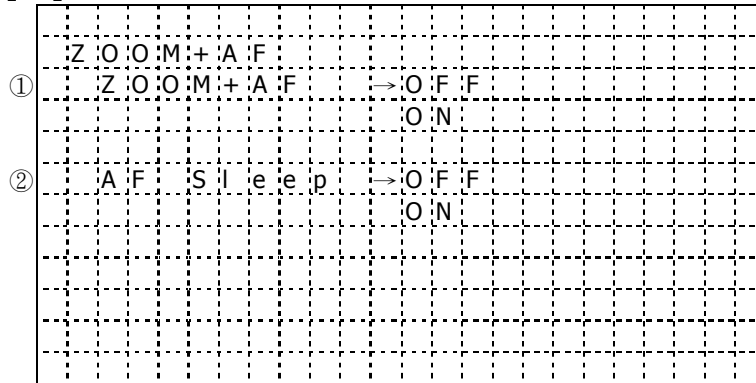

This is used to select an occasion for auto focus action.

- ①ZOOM stops time execute lens focus once, action OFF / ON select.
- ②AF Sleep function ON / OFF select.

(As show screen stillness about 5 minutes cameras come into AF Sleep mode namely, as screen has bigger change time come back again act for normal mode namely.)

**[18]. LANGUAGE MENU**

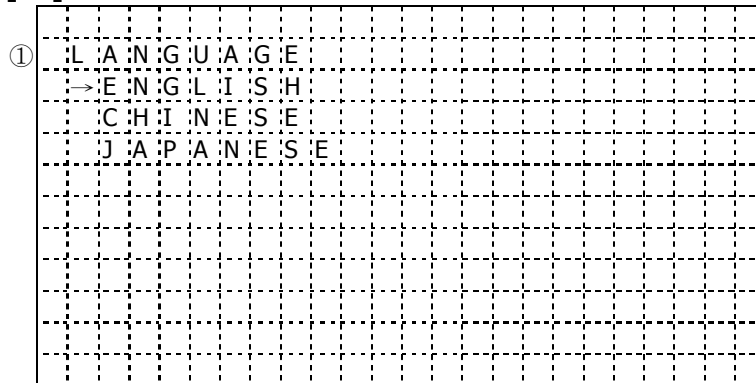

This is used to select OSD manu display language.

- ①OSD display language select, ENGLISH / CHINESE(Simp.) / JAPANESE

**[19]. COMMUNICATION ID MENU**

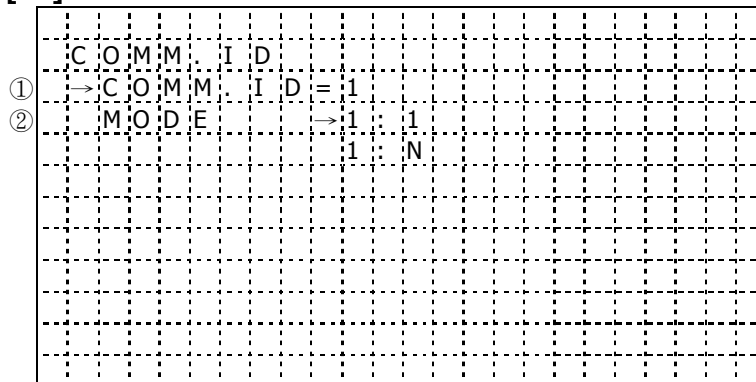

This is used to select communication ID and mode.

- ①Communication ID number's set.(Enactment supply controller identification camera uses ID number.)
- ②MODE choice
  - 1:1 : One controller to control one Camera.
  - 1:N : One controller to control many Camera.

※The specifications and appearance of the product may change without notice.