

Kokyo

株式会社 光響

Email : info@symphotony.com

Web : <https://www.symphotony.com/>

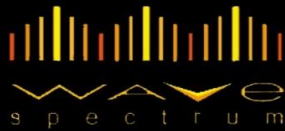

WAVE
s p e c t r u m

CATALOG

Triplex (RGB) Fiber Coupled

White Light Laser Module



Product Portfolio

630nm 633nm
635nm 638nm
640nm 650nm
653nm 660nm
670nm 680nm
685nm 690nm

Red Laser

705nm
730nm 755nm 760nm
770nm 780nm 785nm
790nm 808nm 820nm
830nm 850nm 860nm
880nm 905nm 915nm
940nm 960nm 980nm
1064nm

IR Laser

505nm 510nm
520nm 525nm
532nm

Green Laser



Laser Diode



Fiber Coupled Laser Module

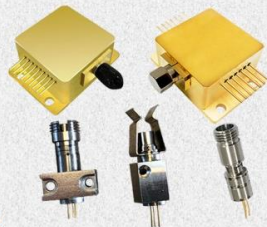

Fiber Detachable Laser Module



Laser System

425nm
435nm 445nm
450nm 455nm
460nm 465nm
473nm 480nm
488nm 495nm

Blue Laser

375nm
395nm 400nm
405nm 410nm
413nm

UV Laser

1270nm
1290nm 1310nm
1330nm 1350nm 1370nm
1390nm 1410nm 1430nm
1450nm 1470nm 1490nm
1510nm 1530nm 1550nm
1570nm 1590nm 1610nm
1625nm 1650nm
1920nm

IR Laser



WAVESPECTRUM GROUP was founded in 1999. It is comprised by a group of experienced and innovative experts in the fields of laser physics, materials science, electronic technology and mechanical design. It has established solid cooperation with some famous universities, research institutes and laboratories.

Wavespectrum products are widely used in space science, optical communication technology, laser display, laser medical, life sciences and materials processing. With the rapid development, R&D centers and production bases have been established in China and Europe. The current plant area is 4,000 square meters, including 2,000 square meters of Class 1,000 clean workshops.

Wavespectrum products include laser diodes, fiber-coupled laser modules and fiber-coupled laser systems with wavelengths from 375nm to 1920nm. Our products are used in medical, printing, laser display, life science, laser communication and other fields. At present, the products have all passed the certifications of ROHS, REACH, CE, etc. At the same time, we have got ISO9001 quality management system certification.

Wavespectrum has world-class R&D team, and it has the world first-class production processing plants. Our products can meet the military-grade production and design standards. The products are well acclaimed world-wide, such in Germany, Austria, the United States, Japan, South Korea and other parts of the world. We have established close cooperation with a number of well-known enterprises world-wide.

Wavespectrum offers laser products with wavelength ranges from 375nm to 1920nm.

375nm	395nm	400nm	405nm	410nm	413nm	435nm	445nm	450nm	455nm	460nm	465nm	473nm
480nm	488nm	495nm	505nm	510nm	520nm	525nm	532nm	630nm	633nm	635nm	638nm	640nm
650nm	653nm	660nm	670nm	680nm	685nm	690nm	705nm	730nm	755nm	760nm	770nm	780nm
785nm	790nm	808nm	820nm	830nm	850nm	860nm	880nm	905nm	915nm	940nm	960nm	980nm
1064nm	1210nm	1270nm	1280nm	1290nm	1310nm	1330nm	1350nm	1370nm	1390nm	1410nm	1430nm	1450nm
1470nm	1490nm	1510nm	1530nm	1550nm	1570nm	1590nm	1610nm	1625nm	1650nm	1720nm	1900nm	1920nm

Pls visit our website for more detailed information: <http://en.wavespectrum-laser.com.cn>

CONTACT US

Wavespectrum Laser Group Limited

Address : 2-2-1504, 2# Haitai Innovation 6th Road, Xiqing Dist, 300392, TianJin, China

Web : www.wavespectrum-laser.com.cn

Email : sales@wavespectrum-laser.com.cn

Tel : +86-022-87931118

Fax : +86-022-86392109

Distributors Wanted World-Wide!

Product Catalogue

Single Mode Laser Diode



Multi-mode Laser Diode



Single Mode Fiber Coupled Laser Module



Multi-mode Fiber Coupled Laser Module



Single Mode Fiber Detachable Laser Module



Multi-mode Fiber Detachable Laser Module



405nm Fiber Detachable Laser Module



405nm High Power Fiber Coupled Laser Source



Medical Laser Module

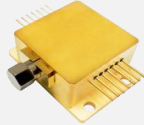

Window Package High Power Laser Diode



Triplex (RGB) Fiber Coupled White Light Laser Module



Triplex (RGB) Fiber Coupled White Light Laser Source



Duplex (Dual-λ) Single Mode Fiber Coupled Laser Module



Red & Green Aiming Beam for Fiber Laser



Product Catalogue

**Turnkey Fiber Coupled
Diode Laser System**



**OEM Fiber Coupled
Diode Laser System**



**3-channel (Multi-channel)
Fiber Coupled Laser System**



**3-wavelength (Multi-λ)
Fiber Coupled Laser System**



**High Power Fiber
Bundled Laser Module**



**Multi-wavelength Fiber
Coupled Laser Module**



Collimated Laser Diode



Photodiode



Triplex (RGB) Fiber Coupled White Light Laser Module

PRODUCT FEATURE

RGB (635nm+520nm+445nm) Solution
 SMF/MMF/PMF Optional
 White Color Laser Output
 Built-in TE Cooler Optional
 Long Lifetime
 High Stability



PRODUCT OVERVIEW

Triplex (RGB) Fiber Coupled White Light Laser Module is the competitive product of WAVESPECTRUM.

We couple the Red (635nm), Green (520nm) and Blue (445nm) Laser into one piece of fiber to get the white Color Laser. The Fiber Type can be Single mode Fiber (SMF) , Multimode Fiber (MMF) and Polarization Maintaining Fiber (PMF) . The fiber core can be 4um, 9um, 105um, etc. The output power can be up to 200mW. By controlling the ratio of RGB Lasers, we can get a perfect white laser. Meanwhile, by adjusting the ratio, various colors of laser also can be obtained.

WAVESPECTRUM also offer the Customized Solution for Triplex Laser Modules, such as Customized Wavelength, Customized Power and Customized Fiber Core to meet the special needs of customers.

WAVESPECTRUM use laser welding technology to guarantee the long-term reliability of the laser structure. To ensure the long-term reliability, each laser diode will undergo rigorous testing and aging in the factory. Meanwhile the high-low storage temperature circulation is also necessary for each laser diode. We set the storage temperature range from -40°C to +85°C, and it lasts 10 cycles, which will ensure the long-term reliability of the coupling structure.



Fiber Type	Part Number	Port-1	Port-2	Port-3	Package	Fiber Core	TEC	Connecto
SMF	Triplex-WSLX-RGB-010m-4-H-T	638nm/10mW	520nm/10mW	445nm/10mW	HHL-01	3um	√	FC/SMA905
	Triplex-WSLP-RGB-010m-4	638nm/10mW	520nm/10mW	445nm/10mW	Coaxial	3um	×	FC/SMA905
	Triplex-WSLX-RGB-015m-4-H-T	638nm/15mW	520nm/15mW	445nm/15mW	HHL-01	3um	√	FC/SMA905
	Triplex-WSLP-RGB-015m-4	638nm/15mW	520nm/15mW	445nm/15mW	Coaxial	3um	×	FC/SMA905
	Triplex-WSLX-RGB-020m-4-H-T	638nm/20mW	520nm/20mW	445nm/20mW	HHL-01	3um	√	FC/SMA905
	Triplex-WSLP-RGB-020m-4	638nm/20mW	520nm/20mW	445nm/20mW	Coaxial	3um	×	FC/SMA905
SMF-28	Triplex-WSLX-RGB-030m-9-H-T	638nm/30mW	520nm/30mW	445nm/30mW	HHL-01	9um	√	FC/SMA905
	Triplex-WSLP-RGB-030m-9	638nm/30mW	520nm/30mW	445nm/30mW	Coaxial	9um	×	FC/SMA905
	Triplex-WSLX-RGB-050m-9-H-T	638nm/50mW	520nm/50mW	445nm/50mW	HHL-01	9um	√	FC/SMA905
	Triplex-WSLP-RGB-050m-9	638nm/50mW	520nm/50mW	445nm/50mW	Coaxial	9um	×	FC/SMA905
MMF	Triplex-WSLX-RGB-030m-M-H-T	638nm/30mW	520nm/30mW	445nm/30mW	HHL-01	105um	√	FC/SMA905
	Triplex-WSLP-RGB-030m-M	638nm/30mW	520nm/30mW	445nm/30mW	Coaxial	105um	×	FC/SMA905
	Triplex-WSLX-RGB-050m-M-H-T	638nm/50mW	520nm/50mW	445nm/50mW	HHL-01	105um	√	FC/SMA905
	Triplex-WSLP-RGB-050m-M	638nm/50mW	520nm/50mW	445nm/50mW	Coaxial	105um	×	FC/SMA905
	Triplex-WSLX-RGB-080m-M-H-T	638nm/80mW	520nm/80mW	445nm/80mW	HHL-01	105um	√	FC/SMA905
	Triplex-WSLP-RGB-080m-M	638nm/80mW	520nm/80mW	445nm/80mW	Coaxial	105um	×	FC/SMA905
	Triplex-WSLX-RGB-100m-M-H-T	638nm/100mW	520nm/100mW	445nm/100mW	HHL-01	105um	√	FC/SMA905
	Triplex-WSLP-RGB-100m-M	638nm/100mW	520nm/100mW	445nm/100mW	Coaxial	105um	×	FC/SMA905
	Triplex-WSLX-RGB-001-M-H-T	638nm/1W	520nm/1W	445nm/1W	HHL-03	105um	√	FC/SMA905

Note: √:Yes, ○:Optional, ×:No.

Various Wavelength Optional	
Port-1	405nm 445nm
Port-2	488nm 505nm 520nm 525nm
Port-3	638nm 658nm 670nm 685nm 785nm

Various Fiber Type Optional	
SMF	3um
PMF	3um
MMF	9um 50um 105um 200um

Laser Beam With SMF:

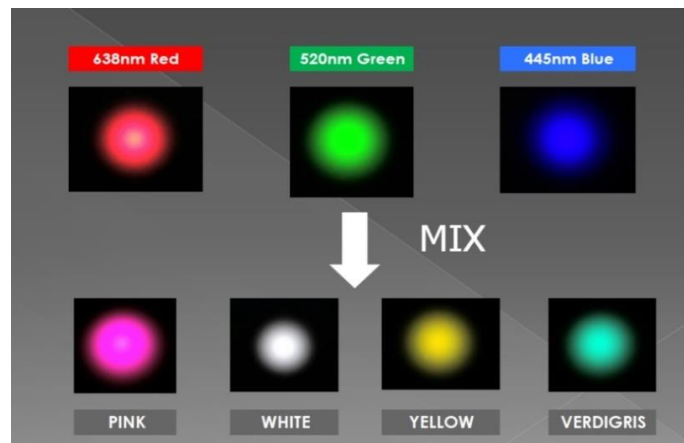

Triplex Package View :

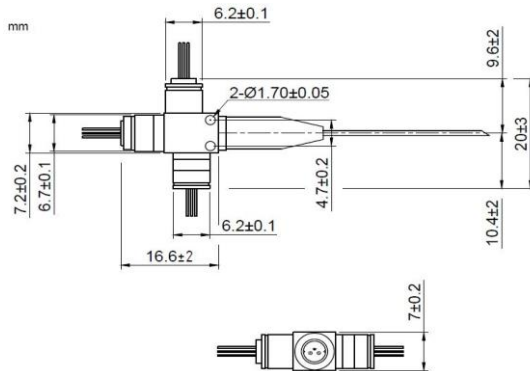

Triplex HHL-01 Package View :

