

Laser Chip on Submount

Key Features

Distributed Feed Back (DFB)
Laser

InGaAsP Strained Quantum
Well Laser Structure on InP

Buried Ridge Stripe (BRS)

Low Beam Divergence
(FWHM) of 25° x 25°

Output Power: 20mW, 40mW
and 60mW

C -Band
(1529nm – 1570nm)
50 GHz Wavelength Spacing

Applications

CW Operation
&
HF Operation up to 2.5GHz

Telecom TDM and DWDM

Instrumentation

1953LCV1

Laser Chip on Submount

1953LCV1 chip is a high performance DFB chip incorporating a Gas Source Molecular Beam Epitaxy (GS-MBE) strained layer multiple quantum well (SLMQW) vertical structure on an InP substrate and a Buried Ridge Stripe (BRS) structure. The BRS structure, achieved with Metal Organic Vapour Phase Deposition (MOVPE) regrowth is performed on 2" wafers whereas facet coatings are made on bars.

This product is available on the whole C-band (1529nm – 1570nm)

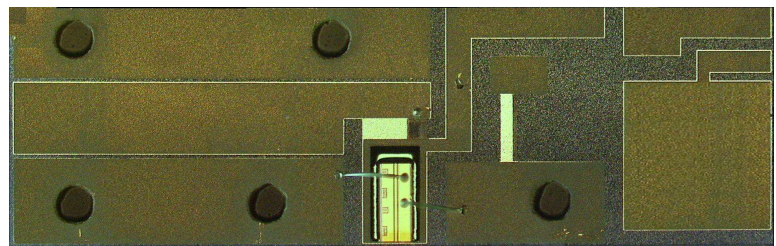

For more info

Please contact us at:

North America: **514.748.4848**
888.922.1044

Europe & Asia: **+33 (0) 1 69 80 58 33**
or via e-mail at **sales@3spgroup.com**

Kokyo

株式会社 光響

Email : info@symphotony.com

Web : <https://www.symphotony.com/>

Laser
1953LCV1
Chip on Submount

3SP Group

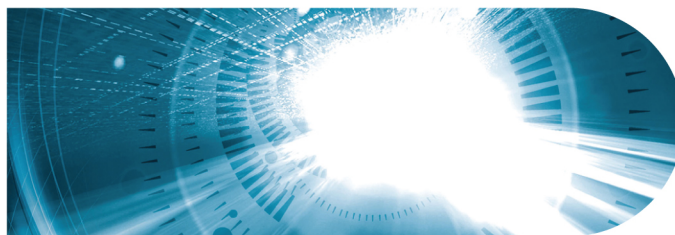

2

ELECTRO-OPTICAL CHARACTERISTICS

All parameters are specified at 25°C Submount Temperature

Parameters	Conditions	Symbol	Min	Max	Unit
Drive Current Threshold	Intersection point with the x-axis of the P _I linear fit curve between 0.2mW and 0.8 mW	I _{th}	-	30	mA
External Efficiency		Eta	0.22	-	mW/mA
Nominal Optical output Power	200 mA	P ₂₀₀	20	-	mW
Maximum Optical Output Power		P _{max}	63	-	mW
Current without kink		I _f w/o kink	300	-	mA
Serial Resistance	V _I linear fit curve between 2mW and 15 mW	R _s	-	2.5	Ohm
Peak Emission Wavelength	P _f =40 mW	L _{da P}	(*)	(*)	nm
Side Mode Suppression ratio	P _f =40 mW	SMSR	35		dB
Parallel Beam Divergence	I _f =200mA	Par B D		25	°
Perpendicular Beam Divergence	I _f =200mA	Per B D		25	°

(*)
Peak Emission Wavelength is defined in "Ordering Information" section.

ABSOLUTE MAXIMUM RATINGS

Exposing the device to stresses above those listed in this section could cause permanent damage. The device is not meant to operate under conditions outside the operational limits described in subsequent sections. Exposure to absolute maximum rating conditions for extended periods may adversely affect device reliability.

Parameter Conditions	Symbol	Min	Max	Unit
Storage Temperature	T _{stg}	-40	+85	°C
Operating temperature	T _{op}	-40	+85	°C
Forward Drive Current	I _f max	-	500	mA
Reverse Voltage	V _r max	-	2	V
ESD (Human Body Model)	V ESD		1 000	V

Laser
1953LCV1
Chip on Submount

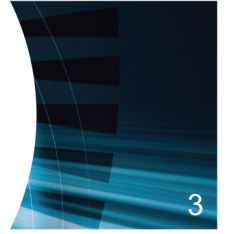

DIMENSIONS AND WIRING

Submount dimensions :
Length : 6.00 mm +/-0.05
Width : 2.00 mm +/- 0.05
Thickness : 0.535 mm +/- 0.03

- **CW use**

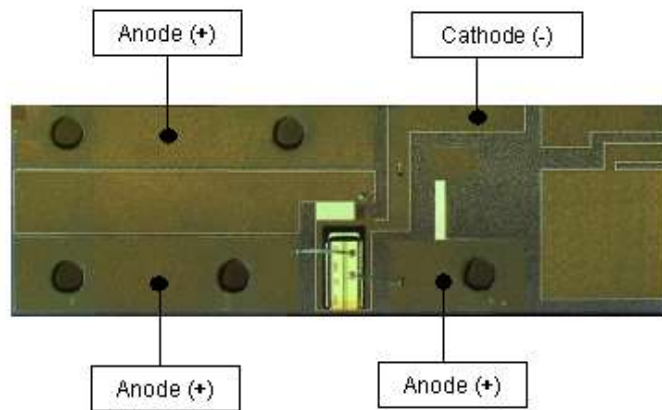

- **HF use**

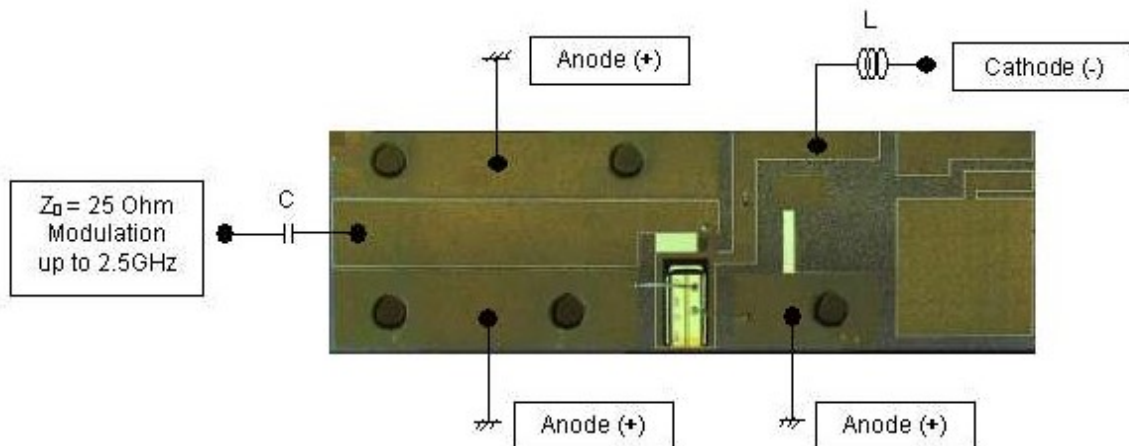

Laser
1953LCV1
Chip on Submount

3SPGroup

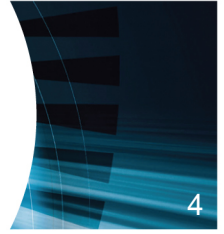
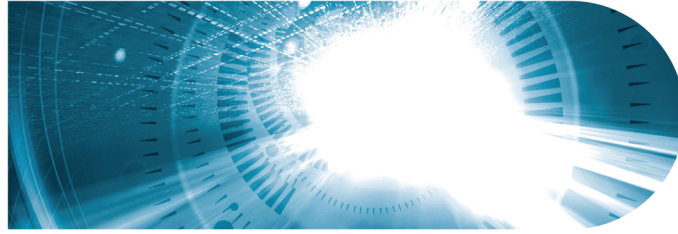

QUALIFICATION and RELIABILITY

1953 LCV1 laser chip is qualified based on Telcordia GR-468-Core recommendations.

Wear Out Failure In Time is lower than 100 FIT

- for 15 years duration
- at chip conditions of :
 - . 40 mW Output Power
 - . and 25°C temperature

LASER SAFETY INFORMATION

Appropriate precautions should be taken to prevent undue exposure to naked eye.
This product is classified Class 3B Laser Chip according to IEC 60825-1.

HANDLING

This product is to be used in a class 10.000 clean room (ISO 7 standard) at the following recommended conditions : 19~23°C and 40~60% HR

This product is sensitive to electrostatic discharge and should not be handled except at a static free workstation. Appropriate precautions should be taken to prevent ESD : use wrist straps, grounded work surfaces and anti-static techniques when handling the device.

Care should be taken to avoid supply transient and over voltage that can cause electrical overstress damage to the chip. Over voltage above the maximum specified in absolute maximum rating section may cause permanent damage to the device.

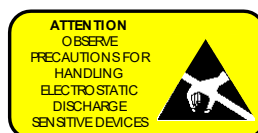

Laser 1953LCV1

Chip on Submount

3SPGroup

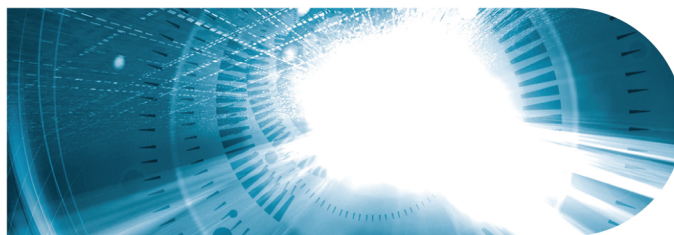

5

ORDERING INFORMATION

Generic code depends on Output Power requirements (Please contact your Sales Manager)
Code related to wavelength is defined as follow :

Lda Code	Lda Min (nm)	Lda Max (nm)
BP	1528.82	1529.62
BQ	1529.21	1530.01
BR	1529.60	1530.40
BS	1530.00	1530.79
BT	1530.39	1531.18
BU	1530.78	1531.57
BV	1531.17	1531.96
BW	1531.56	1532.35
BX	1531.95	1532.75
BY	1532.34	1533.14
BZ	1532.74	1533.53
CA	1533.13	1533.92
CB	1533.52	1534.32
CC	1533.91	1534.71
CD	1534.31	1535.10
CE	1534.70	1535.49
CF	1535.09	1535.89
CG	1535.49	1536.28
CH	1535.88	1536.67
CJ	1536.27	1537.07
CK	1536.67	1537.46
CL	1537.06	1537.86
CM	1537.46	1538.25
CN	1537.85	1538.65
CP	1538.25	1539.04
CQ	1538.64	1539.44

Lda Code	Lda Min (nm)	Lda Max (nm)
CR	1539.04	1539.83
CS	1539.43	1540.23
CT	1539.83	1540.62
CU	1540.22	1541.02
CV	1540.62	1541.41
CW	1541.02	1541.81
CX	1541.41	1542.21
CY	1541.81	1542.60
CZ	1542.21	1543.00
DA	1542.60	1543.40
DB	1543.00	1543.80
DC	1543.40	1544.19
DD	1543.80	1544.59
DE	1544.19	1544.99
DF	1544.59	1545.39
DG	1544.99	1545.79
DH	1545.39	1546.18
DJ	1545.79	1546.58
DK	1546.19	1546.98
DL	1546.59	1547.38
DM	1546.99	1547.78
DN	1547.39	1548.18
DP	1547.78	1548.58
DQ	1548.19	1548.98
DR	1548.59	1549.38
DS	1548.99	1549.78

Lda Code	Lda Min (nm)	Lda Max (nm)
DT	1549.39	1550.18
DU	1549.79	1550.58
DV	1550.19	1550.98
DW	1550.59	1551.38
DX	1550.99	1551.79
DY	1551.39	1552.19
DZ	1551.79	1552.59
EA	1552.20	1552.99
EB	1552.60	1553.39
EC	1553.00	1553.80
ED	1553.40	1554.20
EE	1553.81	1554.60
EF	1554.21	1555.01
EG	1554.61	1555.41
EH	1555.02	1555.81
EJ	1555.42	1556.22
EK	1555.83	1556.62
EL	1556.23	1557.02
EM	1556.63	1557.43
EN	1557.04	1557.83
EP	1557.44	1558.24
EQ	1557.85	1558.64
ER	1558.25	1559.05
ES	1558.66	1559.45
ET	1559.06	1559.86
EU	1559.47	1560.27

Lda Code	Lda Min (nm)	Lda Max (nm)
EV	1559.88	1560.67
EW	1560.28	1561.08
EX	1560.69	1561.48
EY	1561.10	1561.89
EZ	1561.50	1562.30
FA	1561.90	1562.71
FB	1562.32	1563.11
FC	1562.73	1563.52
FD	1563.13	1563.93
FE	1563.54	1564.34
FF	1563.95	1564.74
FG	1564.36	1565.15
FH	1564.77	1565.56
FJ	1565.17	1565.97
FK	1565.58	1566.38
FL	1565.99	1566.79
FM	1566.40	1567.20
FN	1566.81	1567.61
FP	1567.22	1568.02
FR	1567.63	1568.43
FS	1568.04	1568.84
FT	1568.45	1569.25
FU	1568.86	1569.66

Revised Oct 2013
RCL IMA DSH 000 00056

Please note: information in this document is typical and must be specifically confirmed in writing by your supplier before it becomes applicable to any order or contract.
Information is subject to change without notice.
©2011 3S PHOTONICS S.A.S

ORDERING INFO

Please contact your Sales Manager. 3SPGroup can also develop custom products to meet a wide range of technical requirements.

3SPGroup

North America: 514.748.4848
888.922.1044

Europe and Asia: +33 (0)1 69 80 58 33
www.3spgroup.com • sales@3spgroup.com

