

705nm 15mw SM Coaxial Pigtailed LD with PM Fiber

705nm Fiber Coupled Laser Diode with PMF

WSLP-705-015m-PM-PD

Wavespectrum laser inc.

www.wavespectrum-laser.com

PARAMETER	SYMBOL	VALUE	UNIT
Reverse Voltage	V_r	2.0	V
Operating Temperature	T_{op}	-10 ~ +60	°C
Storage Temperature	T_{stg}	-40 ~ +85	°C
Lead soldering temperature (10 sec.)	T_{is}	260	°C
Features: <ul style="list-style-type: none"> ● 705nm ● 4um PM Fiber ● Coaxial package ● Built-in PD 			
Applications: <ul style="list-style-type: none"> ● Medical laser treatment ● others 			
Specifications	WSLP-705-015m-PM-PD		
	Min	Type	Max
Center Wavelength@25°C	695nm	705nm	715nm
Spectral Width (FWHM)	----	----	2.0nm
Output Power	----	----	15mw
Fiber Core	4um Polarization Maintaining Fiber		
Slope Efficiency	0.7mW/mA	0.9mW/mA	1.4mW/mA
Monitor Current	0.15mA	0.3mA	0.6mA
PD Reverse Voltage	----	30V	----
Fiber Connector	FC/ST/SMA905		
Fiber Length	----	80cm	100cm
Threshold Current (Typ.)	----	30mA	60mA
Operating Current (Typ.)	----	75mA	100mA
Operating Voltage	----	2.5V	----
Package Style	Coaxial		



Coaxial Package View

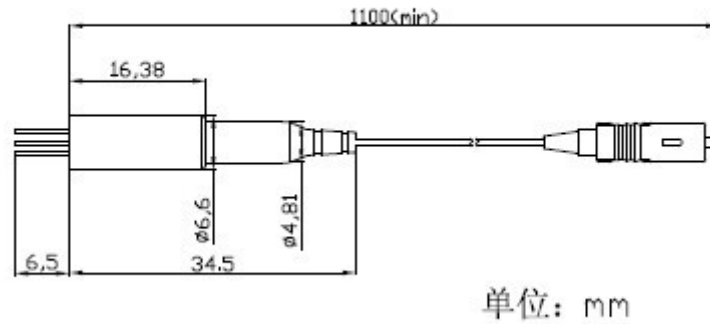

PIN Bottom View:



1	LD(+)
2	LD(-)&PD(+)
3	PD(-)

Electrically shorten LD module and store in non-extreme conditions.

Suggest using the constant current power supply.

Caution

On operation, if optical connectors are unterminated, modules can emit invisible laser radiation. Radiation emitted by laser devices can be dangerous to the eyes. Avoided eye or skin exposure to direct or scattered radiation.

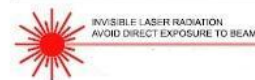

Invisible Laser Radiation
 Avoid Direct Exposure to Beam
 Class 3B Laser Product

