

Kokyo

株式会社 光響  
〒600-8411  
京都市下京区烏丸通四条下ル水銀屋町637番地 第5長谷ビル2階  
WEB: <https://www.symphotony.com/>



# CATALOG

## Single Mode Laser Diode

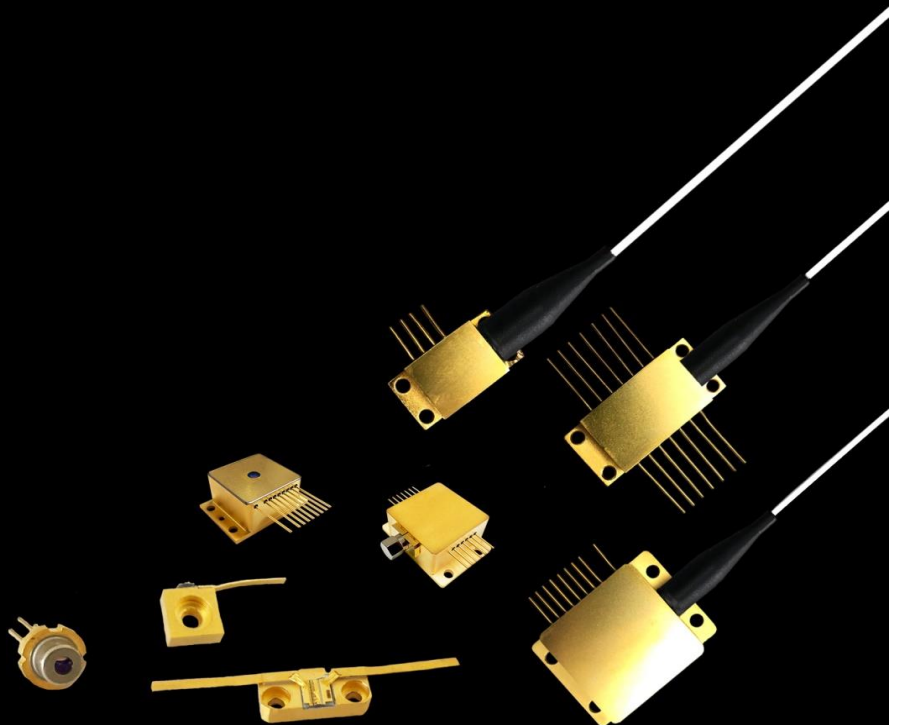

# Product Portfolio

630nm 633nm  
635nm 638nm  
640nm 650nm  
653nm 660nm  
670nm 680nm  
685nm 690nm

Red Laser

705nm  
730nm 755nm 760nm  
770nm 780nm 785nm  
790nm 808nm 820nm  
830nm 850nm 860nm  
880nm 905nm 915nm  
940nm 960nm 980nm  
1064nm

IR Laser

505nm 510nm  
520nm 525nm  
532nm

Green Laser



Laser Diode



Fiber Coupled Laser Module

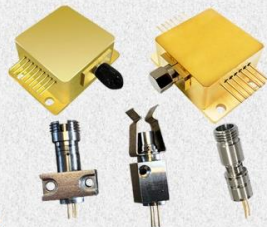

Fiber Detachable Laser Module



Laser System

425nm  
435nm 445nm  
450nm 455nm  
460nm 465nm  
473nm 480nm  
488nm 495nm

Blue Laser

375nm  
395nm 400nm  
405nm 410nm  
413nm

UV Laser

1270nm  
1290nm 1310nm  
1330nm 1350nm 1370nm  
1390nm 1410nm 1430nm  
1450nm 1470nm 1490nm  
1510nm 1530nm 1550nm  
1570nm 1590nm 1610nm  
1625nm 1650nm  
1920nm

IR Laser



**WAVESPECTRUM GROUP** was founded in 1999. It is comprised by a group of experienced and innovative experts in the fields of laser physics, materials science, electronic technology and mechanical design. It has established solid cooperation with some famous universities, research institutes and laboratories.

Wavespectrum products are widely used in space science, optical communication technology, laser display, laser medical, life sciences and materials processing. With the rapid development, R&D centers and production bases have been established in China and Europe. The current plant area is 4,000 square meters, including 2,000 square meters of Class 1,000 clean workshops.

Wavespectrum products include laser diodes, fiber-coupled laser modules and fiber-coupled laser systems with wavelengths from 375nm to 1920nm. Our products are used in medical, printing, laser display, life science, laser communication and other fields. At present, the products have all passed the certifications of ROHS, REACH, CE, etc. At the same time, we have got ISO9001 quality management system certification.

Wavespectrum has world-class R&D team, and it has the world first-class production processing plants. Our products can meet the military-grade production and design standards. The products are well acclaimed world-wide, such in Germany, Austria, the United States, Japan, South Korea and other parts of the world. We have established close cooperation with a number of well-known enterprises world-wide.

**Wavespectrum offers laser products with wavelength ranges from 375nm to 1920nm.**

375nm	395nm	400nm	405nm	410nm	413nm	435nm	445nm	450nm	455nm	460nm	465nm	473nm
480nm	488nm	495nm	505nm	510nm	520nm	525nm	532nm	630nm	633nm	635nm	638nm	640nm
650nm	653nm	660nm	670nm	680nm	685nm	690nm	705nm	730nm	755nm	760nm	770nm	780nm
785nm	790nm	808nm	820nm	830nm	850nm	860nm	880nm	905nm	915nm	940nm	960nm	980nm
1064nm	1210nm	1270nm	1280nm	1290nm	1310nm	1330nm	1350nm	1370nm	1390nm	1410nm	1430nm	1450nm
1470nm	1490nm	1510nm	1530nm	1550nm	1570nm	1590nm	1610nm	1625nm	1650nm	1720nm	1900nm	1920nm

Pls visit our website for more detailed information: <http://en.wavespectrum-laser.com.cn>

## CONTACT US

### Wavespectrum Laser Group Limited

Address : 2-2-1504, 2# Haitai Innovation 6th Road, Xiqing Dist, 300392, TianJin, China

Web : [www.wavespectrum-laser.com.cn](http://www.wavespectrum-laser.com.cn)

Email : [sales@wavespectrum-laser.com.cn](mailto:sales@wavespectrum-laser.com.cn)

Tel : +86-022-87931118

Fax : +86-022-86392109

**Distributors Wanted World-Wide!**

# Product Catalogue

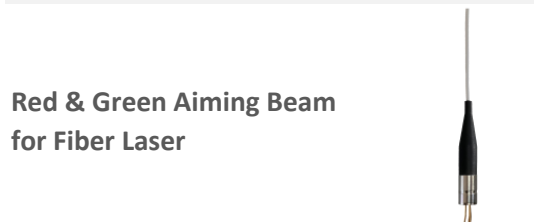
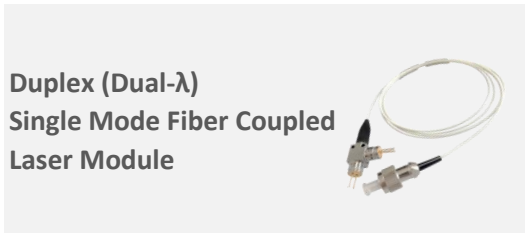
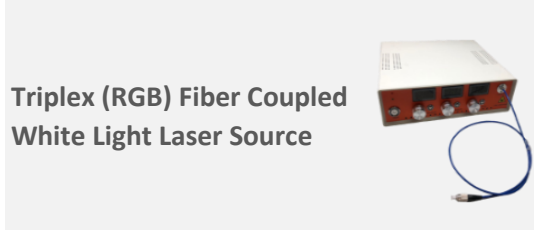
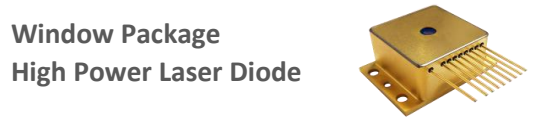
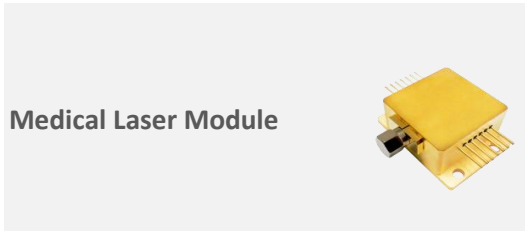
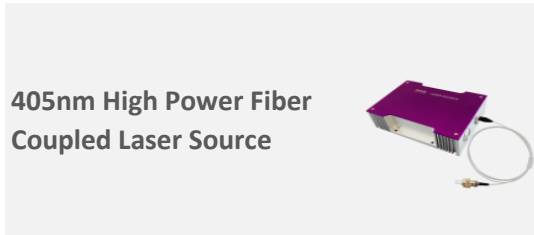
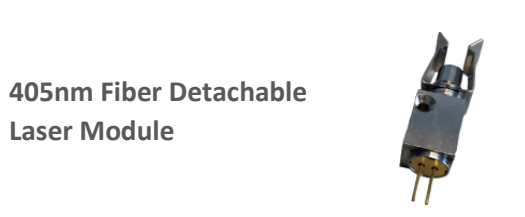
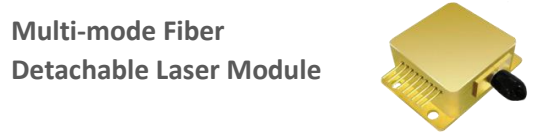
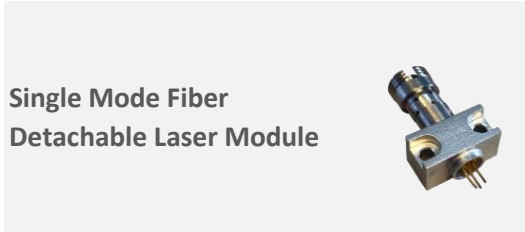
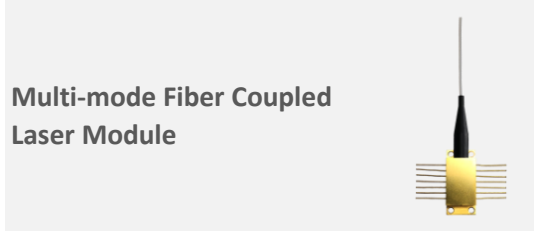
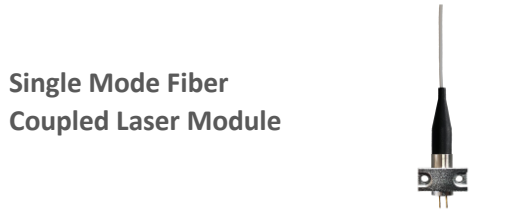
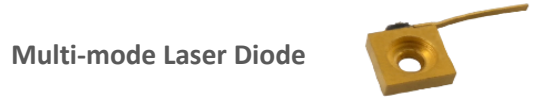

## Product Catalogue

**Turnkey Fiber Coupled  
Diode Laser System**



**OEM Fiber Coupled  
Diode Laser System**



**3-channel (Multi-channel)  
Fiber Coupled Laser System**



**3-wavelength (Multi-λ)  
Fiber Coupled Laser System**



**High Power Fiber  
Bundled Laser Module**



**Multi-wavelength Fiber  
Coupled Laser Module**



**Collimated Laser Diode**



**Photodiode**



## Single Mode Laser Diode

### PRODUCT FEATURE

405nm~1650nm  
 Single Mode Beam Output  
 10mW~300mW Output Power  
 TO38 / TO18 / TO5 Package  
 Built-in Photodiodes Optional  
 Long Lifetime  
 High Stability



### PRODUCT OVERVIEW

Single Mode Laser Diode is the competitive product of WAVESPECTRUM.

We offer the high quality Laser Diode with single mode beam, the wavelength range is from 405nm to 1650nm and the output power ranges from 5mW to 300mW. The photodiode is optional for customers. Now the standard package can be TO38, TO18 and TO5 Package.

WAVESPECTRUM adopt AuSn solder technology to package the laser diode. To ensure the long-term reliability, each laser diode will undergo rigorous testing and aging in factory. Meanwhile the high-low storage temperature circulation is also necessary for each laser diode. We set the storage temperature range from -40°C to +85°C, and it lasts 10 cycles, which will ensure the long-term stability of laser diode.





Wavelength	Part Number	Output Power	Mode Type	Laser Type	Package	PD	FAC	TEC
405nm	WSLD-405-020m-1-PD	20mW	SM	FP	TO18	√	x	x
	WSLD-405-120m-1	120mW	SM	FP	TO18	x	x	x
	WSLD-405-120m-1-PD	120mW	SM	FP	TO18	√	x	x
	WSLD-405-150m-1(3.8mm)	150mW	SM	FP	TO38	x	x	x
	WSLD-405-150m-1	150mW	SM	FP	TO18	x	x	x
	WSLD-405-150m-1-PD	150mW	SM	FP	TO18	√	x	x
	WSLD-405-200m-1	200mW	SM	FP	TO38	x	x	x
	WSLD-405-250m-1	250mW	SM	FP	TO18	x	x	x
WSLD-405-300m-1(SM)	300mW	SM	FP	TO18	x	x	x	
445nm	WSLD-445-100m-1(5.6mm)	100mW	SM	FP	TO18	x	x	x
460nm	WSLD-460-100m-1	100mW	SM	FP	TO18	x	x	x
480nm	WSLD-480-060m-1	60mW	SM	FP	TO18	x	x	x
	WSLD-480-080m-1	80mW	SM	FP	TO18	x	x	x
488nm	WSLD-488-060m-1	60mW	SM	FP	TO18	x	x	x
	WSLD-488-080m-1	80mW	SM	FP	TO18	x	x	x
	WSLD-488-100m-1	100mW	SM	FP	TO18	x	x	x
495nm	WSLD-495-060m-1	60mW	SM	FP	TO18	x	x	x
	WSLD-495-080m-1	80mW	SM	FP	TO18	x	x	x
505nm	WSLD-505-050m-1	50mW	SM	FP	TO18	x	x	x
	WSLD-505-080m-1	80mW	SM	FP	TO18	x	x	x
510nm	WSLD-510-050m-1	50mW	SM	FP	TO18	x	x	x
	WSLD-510-080m-1	80mW	SM	FP	TO18	x	x	x
520nm	WSLD-520-010m-1-PD	10mW	SM	FP	TO18	√	x	x
	WSLD-520-030m-1-PD	30mW	SM	FP	TO18	√	x	x
	WSLD-520-050m-1-PD	50mW	SM	FP	TO18	√	x	x
	WSLD-520-080m-1-PD	80mW	SM	FP	TO18	√	x	x
	WSLD-520-140m-1	140mW	SM	FP	TO18	x	x	x
525nm	WSLD-525-080m-1-PD	80mW	SM	FP	TO18	√	x	x
635nm	WSLD-635-015m-1-PD	15mW	SM	FP	TO18	√	x	x
	WSLD-635-030m-1-PD	30mW	SM	FP	TO18	√	x	x
	WSLD-635-050m-1-PD	50mW	SM	FP	TO18	√	x	x
	WSLD-635-180m-1	180mW	SM	FP	TO18	x	x	x
	WSLD-635-200m-1-PD	200mW	SM	FP	TO18	√	x	x
660nm	WSLD-660-050m-1-PD	50mW	SM	FP	TO18	√	x	x
	WSLD-660-100m-1	100mW	SM	FP	TO18	x	x	x
	WSLD-660-100m-1-PD	100mW	SM	FP	TO18	√	x	x
	WSLD-660-150m-1	150mW	SM	FP	TO18	x	x	x
	WSLD-660-180m-1	180mW	SM	FP	TO18	x	x	x

Note: √:Yes, ○:Optional, x:No.

Wavelength	Part Number	Output Power	Mode Type	Laser Type	Package	PD	FAC	TEC
785nm	WSLD-785-100m-1-PD	100mW	SM	FP	TO18	√	x	x
	WSLD-785-100m-1-PD-R	100mW	SM	FP	TO18	√	x	x
	WSLD-785-120m-1-PD-R	120mW	SM	FP	TO18	√	x	x
820nm	WSLD-820-100m-1-PD	100mW	SM	FP	TO18	√	x	x
	WSLD-820-150m-1-PD	150mW	SM	FP	TO18	√	x	x
830nm	WSLD-830-050m-1-PD	50mW	SM	FP	TO18	√	x	x
	WSLD-830-100m-1-PD	100mW	SM	FP	TO18	√	x	x
	WSLD-830-150m-1-PD	150mW	SM	FP	TO18	√	x	x
	WSLD-830-200m-1-PD	200mW	SM	FP	TO18	√	x	x
	WSLD-830-250m-1-PD	250mW	SM	FP	TO18	√	x	x
850nm	WSLD-850-050m-1-PD	50mW	SM	FP	TO18	√	x	x
880nm	WSLD-880-010m-1-PD	10mW	SM	FP	TO18	√	x	x
905nm	WSLD-905-200m-1-PD	200mW	SM	FP	TO18	√	x	x
940nm	WSLD-940-200m-1-PD	200mW	SM	FP	TO18	√	x	x
	WSLD-940-300m-1-PD	300mW	SM	FP	TO18	√	x	x
980nm	WSLD-980-050m-1-PD	50mW	SM	FP	TO18	√	x	x
1270nm	WSLD-1270-020m-1-PD	20mW	SM	DFB	TO18(with Lens)	√	x	x
	WSLD-1270-020m-1-PD-F	20mW	SM	DFB	TO18	√	x	x
	WSLD-1270-020m-6-T-PD	20mW	SM	DFB	TO6(with TEC)	√	x	√
	WSLD-1270-030m-1-PD	30mW	SM	DFB	TO18(with Lens)	√	x	x
1290nm	WSLD-1290-020m-1-PD	20mW	SM	DFB	TO18(with Lens)	√	x	x
	WSLD-1290-020m-1-PD-F	20mW	SM	DFB	TO18	√	x	x
	WSLD-1290-020m-6-T-PD	20mW	SM	DFB	TO6(with TEC)	√	x	√
	WSLD-1290-030m-1-PD	30mW	SM	DFB	TO18(with Lens)	√	x	x
1310nm	WSLD-1310-020m-1-PD	20mW	SM	DFB	TO18(with Lens)	√	x	x
	WSLD-1310-020m-1-PD-F	20mW	SM	DFB	TO18	√	x	x
	WSLD-1310-020m-6-T-PD	20mW	SM	DFB	TO6(with TEC)	√	x	√
	WSLD-1310-030m-1-PD	30mW	SM	DFB	TO18(with Lens)	√	x	x
	WSLD-1310-030m-1-PD-F	30mW	SM	DFB	TO18	√	x	x
1330nm	WSLD-1330-020m-1-PD	20mW	SM	DFB	TO18(with Lens)	√	x	x
	WSLD-1330-020m-1-PD-F	20mW	SM	DFB	TO18	√	x	x
	WSLD-1330-020m-6-T-PD	20mW	SM	DFB	TO6(with TEC)	√	x	√
	WSLD-1330-030m-1-PD	30mW	SM	DFB	TO18(with Lens)	√	x	x
1350nm	WSLD-1350-020m-1-PD	20mW	SM	DFB	TO18(with Lens)	√	x	x
	WSLD-1350-020m-1-PD-F	20mW	SM	DFB	TO18	√	x	x
	WSLD-1350-020m-6-T-PD	20mW	SM	DFB	TO6(with TEC)	√	x	√
	WSLD-1350-030m-1-PD	30mW	SM	DFB	TO18(with Lens)	√	x	x
1370nm	WSLD-1370-020m-1-PD	20mW	SM	DFB	TO18(with Lens)	√	x	x

Note: √:Yes, ○:Optional, x:No.



Wavelength	Part Number	Output Power	Mode Type	Laser Type	Package	PD	FAC	TEC
1370nm	WSLD-1370-020m-1-PD-F	20mW	SM	DFB	TO18	√	×	×
	WSLD-1370-020m-6-T-PD	20mW	SM	DFB	TO6(with TEC)	√	×	√
	WSLD-1370-030m-1-PD	30mW	SM	DFB	TO18(with Lens)	√	×	×
1390nm	WSLD-1390-020m-1-PD	20mW	SM	DFB	TO18(with Lens)	√	×	×
	WSLD-1390-020m-1-PD-F	20mW	SM	DFB	TO18	√	×	×
	WSLD-1390-020m-6-T-PD	20mW	SM	DFB	TO6(with TEC)	√	×	√
	WSLD-1390-030m-1-PD	30mW	SM	DFB	TO18(with Lens)	√	×	×
1410nm	WSLD-1410-015m-1-PD	15mW	SM	DFB	TO18(with Lens)	√	×	×
	WSLD-1410-015m-1-PD-F	15mW	SM	DFB	TO18	√	×	×
	WSLD-1410-020m-1-PD	20mW	SM	DFB	TO18(with Lens)	√	×	×
	WSLD-1410-020m-6-T-PD	20mW	SM	DFB	TO6(with TEC)	√	×	√
1430nm	WSLD-1430-015m-1-PD	15mW	SM	DFB	TO18(with Lens)	√	×	×
	WSLD-1430-015m-1-PD-F	15mW	SM	DFB	TO18	√	×	×
	WSLD-1430-020m-1-PD	20mW	SM	DFB	TO18(with Lens)	√	×	×
	WSLD-1430-020m-6-T-PD	20mW	SM	DFB	TO6(with TEC)	√	×	√
1450nm	WSLD-1450-015m-1-PD	15mW	SM	DFB	TO18(with Lens)	√	×	×
	WSLD-1450-015m-1-PD-F	15mW	SM	DFB	TO18	√	×	×
	WSLD-1450-020m-1-PD	20mW	SM	DFB	TO18(with Lens)	√	×	×
	WSLD-1450-020m-6-T-PD	20mW	SM	DFB	TO6(with TEC)	√	×	√
1470nm	WSLD-1470-015m-1-PD	15mW	SM	DFB	TO18(with Lens)	√	×	×
	WSLD-1470-015m-1-PD-F	15mW	SM	DFB	TO18	√	×	×
	WSLD-1470-020m-1-PD	20mW	SM	DFB	TO18(with Lens)	√	×	×
	WSLD-1470-020m-6-T-PD	20mW	SM	DFB	TO6(with TEC)	√	×	√
1490nm	WSLD-1490-015m-1-PD	15mW	SM	DFB	TO18(with Lens)	√	×	×
	WSLD-1490-015m-1-PD-F	15mW	SM	DFB	TO18	√	×	×
	WSLD-1490-020m-1-PD	20mW	SM	DFB	TO18(with Lens)	√	×	×
	WSLD-1490-020m-6-T-PD	20mW	SM	DFB	TO6(with TEC)	√	×	√
1510nm	WSLD-1510-015m-1-PD	15mW	SM	DFB	TO18(with Lens)	√	×	×
	WSLD-1510-015m-1-PD-F	15mW	SM	DFB	TO18	√	×	×
	WSLD-1510-020m-1-PD	20mW	SM	DFB	TO18(with Lens)	√	×	×
	WSLD-1510-020m-6-T-PD	20mW	SM	DFB	TO6(with TEC)	√	×	√
1530nm	WSLD-1530-015m-1-PD	15mW	SM	DFB	TO18(with Lens)	√	×	×
	WSLD-1530-015m-1-PD-F	15mW	SM	DFB	TO18	√	×	×
	WSLD-1530-020m-1-PD	20mW	SM	DFB	TO18(with Lens)	√	×	×
	WSLD-1530-020m-6-T-PD	20mW	SM	DFB	TO6(with TEC)	√	×	√
1550nm	WSLD-1550-015m-1-PD	15mW	SM	DFB	TO18(with Lens)	√	×	×
	WSLD-1550-015m-1-PD-F	15mW	SM	DFB	TO18	√	×	×
	WSLD-1550-020m-1-PD	20mW	SM	DFB	TO18(with Lens)	√	×	×

Note: √:Yes, ○:Optional, ×:No.

Wavelength	Part Number	Output Power	Mode Type	Laser Type	Package	PD	FAC	TEC
1550nm	WSLD-1550-020m-1-PD-F	20mW	SM	DFB	TO18	√	×	×
	WSLD-1550-020m-6-T-PD	20mW	SM	DFB	TO6(with TEC)	√	×	√
1570nm	WSLD-1570-015m-1-PD	15mW	SM	DFB	TO18(with Lens)	√	×	×
	WSLD-1570-015m-1-PD-F	15mW	SM	DFB	TO18	√	×	×
	WSLD-1570-020m-1-PD	20mW	SM	DFB	TO18(with Lens)	√	×	×
	WSLD-1570-020m-6-T-PD	20mW	SM	DFB	TO6(with TEC)	√	×	√
1590nm	WSLD-1590-010m-1-PD-F	10mW	SM	DFB	TO18	√	×	×
	WSLD-1590-015m-1-PD	15mW	SM	DFB	TO18(with Lens)	√	×	×
	WSLD-1590-015m-1-PD-F	15mW	SM	DFB	TO18	√	×	×
	WSLD-1590-020m-1-PD	20mW	SM	DFB	TO18(with Lens)	√	×	×
	WSLD-1590-020m-6-T-PD	20mW	SM	DFB	TO6(with TEC)	√	×	√
1610nm	WSLD-1610-010m-1-PD-F	10mW	SM	DFB	TO18	√	×	×
	WSLD-1610-015m-1-PD	15mW	SM	DFB	TO18(with Lens)	√	×	×
	WSLD-1610-015m-1-PD-F	15mW	SM	DFB	TO18	√	×	×
	WSLD-1610-020m-1-PD	20mW	SM	DFB	TO18(with Lens)	√	×	×
	WSLD-1610-020m-6-T-PD	20mW	SM	DFB	TO6(with TEC)	√	×	√
1625nm	WSLD-1625-010m-1-PD-F	10mW	SM	DFB	TO18	√	×	×
	WSLD-1625-015m-1-PD	15mW	SM	DFB	TO18(with Lens)	√	×	×
	WSLD-1625-015m-1-PD-F	15mW	SM	DFB	TO18	√	×	×
	WSLD-1625-020m-1-PD	20mW	SM	DFB	TO18(with Lens)	√	×	×
	WSLD-1625-020m-6-T-PD	20mW	SM	DFB	TO6(with TEC)	√	×	√
1650nm	WSLD-1650-010m-1-PD-F	10mW	SM	DFB	TO18	√	×	×
	WSLD-1650-015m-1-PD	15mW	SM	DFB	TO18(with Lens)	√	×	×
	WSLD-1650-015m-1-PD-F	15mW	SM	DFB	TO18	√	×	×
	WSLD-1650-020m-1-PD	20mW	SM	DFB	TO18(with Lens)	√	×	×
	WSLD-1650-020m-6-T-PD	20mW	SM	DFB	TO6(with TEC)	√	×	√

Note: √:Yes, ○:Optional, ×:No.

**TO38 Package View :**

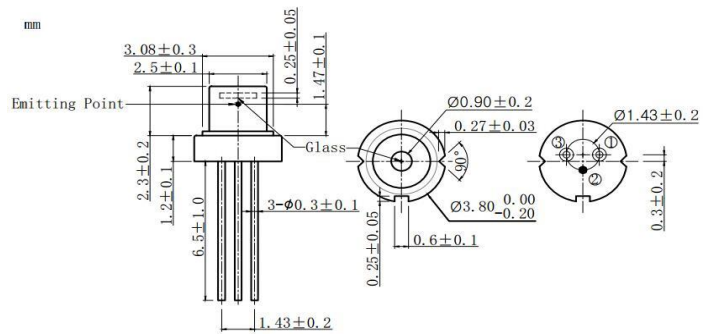

**TO18 Package View :**

